



Desigo™

15.6-inch touch panel

PXM50

For use with web interface PXG3.W100

-
- Compact design with low built-in depth, for mounting in control panel doors
 - High-resolution TFT display with 16.7 million colors
Resolution: 1366 x 768 pixels (wide screen)
 - Capacitive touch screen
 - Dimmable LED background lighting
 - Intuitive operation and monitoring of multiple plants or Desigo PX automation stations
 - Optimized for local operation of the Desigo building automation and control system
 - LED to indicate alarms while the screen is off
 - Connection via Ethernet RJ45
 - Commissioning wizard
 - Remote access via VNC to the touch panel
 - No additional mounting materials required

Use

The Desigo PXM50 touch panel is designed for control panel mounting. It is used together with web interface PXG3.W100 and adapts the standard technology used for the web interface for local operation of the technical installations in the building. The touch panel allows for intuitive operation of multiple Desigo PX automation stations and allows for permanent monitoring of technical installations in a building. TCP/IP is used for communications.

Functions

Plant overview screenshot

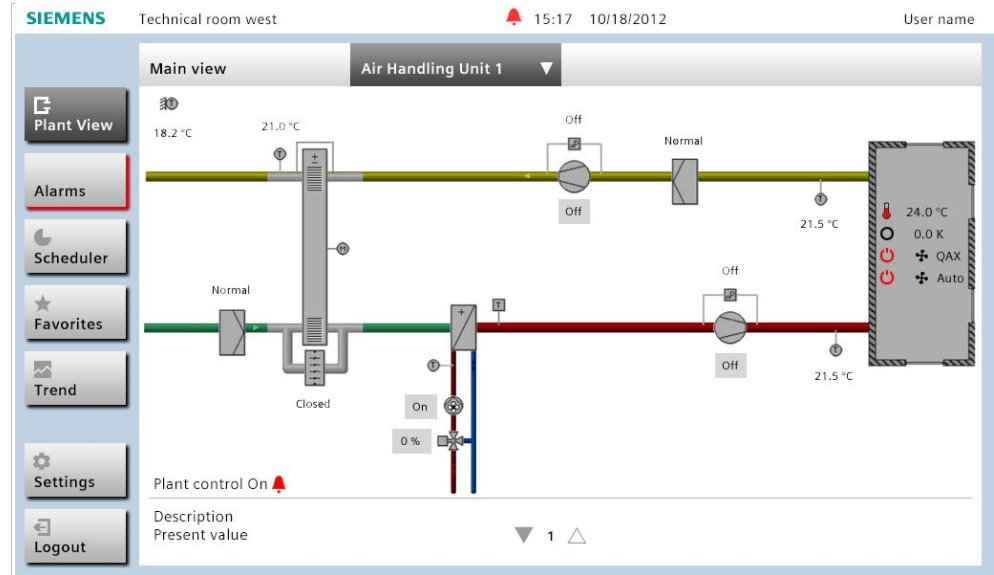

Settings

Different settings are available for user-friendly operation of the touch panel. They can be edited following login.

Function	Description
Brightness	Sets the screen's relative brightness.
Language	Operating language of the touch panel.
Time format	24 or 12-hour (am/pm) display.
Date format	8 variants are available.
Keypad	Keypad layout: Standard QWERTY or Russian.
Auto logout	Time to logout: 5, 10, 15, 30, 45, 60 minutes.
VNC	Remote access to display (Computer → Touch Panel), switches to Off after logging off, default = Off . ⚠ Warning: Activate this function only when needed. The function must be disabled for all other times.
Screensaver	Idle time: 15 minutes, default = On .
SSH	FW Version ≤ V01.15.30.497 only. This function is intended only for internal service, and is thus available only to Siemens employees. Factory setting: Off . ⚠ Warning: Activate this function only when needed. The function must be disabled for all other times.

Number of languages

There are 16 languages supported. English is the default operating language.

Auto logout

Automatic logout can be set at intervals of 5...60 minutes.

Keypad

The keypad is designed for two different language groups:

- Standard (for Latin-based languages and the so-called QWERTY layout), and
- Russian (for Cyrillic languages; just Russian at this time).

Keypad functionality

The interaction with the keypad is roughly the same as commercially available products such as smart phone, tablets, etc.

Alarm LED

Pending alarms are indicated by an LED on the top right of the touch panel.

Detailed documentation

For detailed information on setting and operating the touch panel, see the Operating instructions Desigo Touch and Web CM111028.

Ordering

When ordering, please specify the name and **product number**.

Example:

Touch panel 15.6 inch PXM50

The touch panel is packed individually in a cardboard box and delivered together with the materials required for mounting.

Type	Stock number	Designation
PXM50	S55623-H120	Touch Panel 15.6"

Equipment combinations

Device description	Type (ASN)	Documentation
Web interface BACnet/IP	PXG3.W100	CM1N9294

Product documentation

Document type	Document no.
Data sheet web interface BACnet/IP PXG3.W100	CM1N9294
Installation and commissioning instructions Desigo Touch and Web	CM111029
Operating instructions Desigo Touch and Web	CM111028
Engineering and commissioning: Online help for Xworks Plus	CM111006

Mechanical design

The touch panels are intended for mounting in control panel doors or operating tablets.

15.6" touch panel
Front

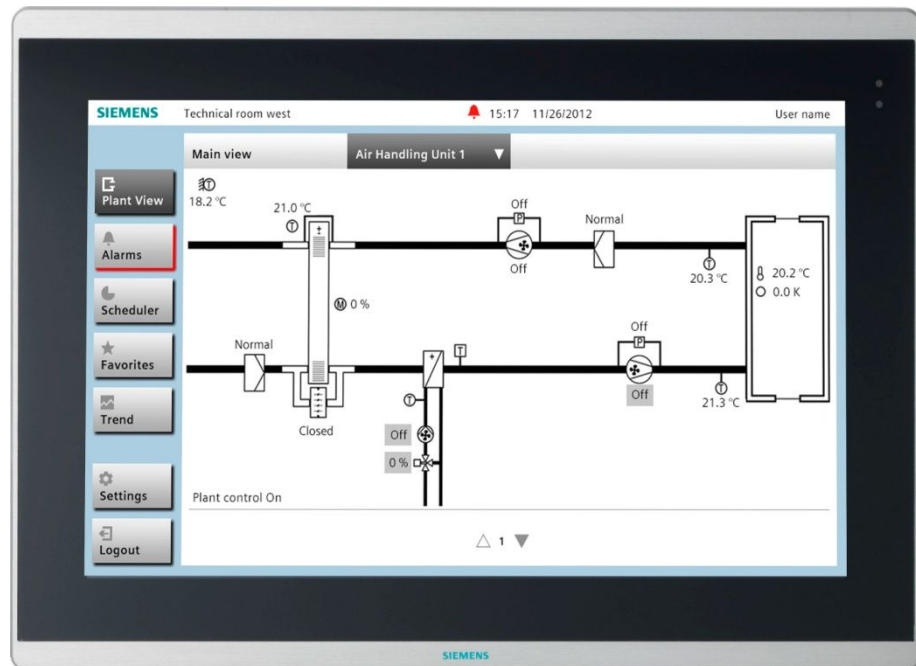

15.6" touch panel
Rear



Engineering

Desigo Xworks Plus is used to engineer Desigo Touch and Web. The application contains an integrated online help for engineering (CM111006en.chm).

Mounting notes

Mounting types

The touch panels can be integrated in the control panel door or in an operating table (e.g. remote control tablet).

Mounting materials: Tension clamps and fixing screws are part of the delivery. The mounting instructions (CM1M9292) are printed on the packaging.

Cutout for PXM50

See "Dimensions".



Commissioning notes

Prerequisites	A properly set up web interface (PXG3.W100) is prerequisite to commissioning the touch panel.
Setting wizard	A setting wizard is available for the network/server settings of the touch panel. For more information, please see the Installation and commissioning instructions Desigo Touch and Web CM111029.
Firmware download	The firmware can be downloaded via USB interface. For more information on firmware download, see the Installation and commissioning instructions Desigo Touch and Web CM111029.



Maintenance

The PXM50 touch panel does not require maintenance.

Technical data

Power	Operating voltage	SELV/PELV AC 24 V (+20% / -20%) DC 24 V (+15% / -15%)
	Nominal voltage	AC 24 V DC 24 V
	Frequency	50/60 Hz
	Max. power consumption	
	At AC 24 V	Max. 26 VA *
	At DC 24 V	Max. 13 W *
		* No load on the USB interfaces
	Screw terminals for wire diameters up to	2.5 mm ²
Display	Size	15.6"
	Resolution	1366 x 768
	Type	TFT
	Number of colors	16.7 million
	Viewing angle H/V	Typically 160°/160°
	Background lighting	LED, dimmable
Touchpad	Type	Projective capacitive
Input/output	Ethernet	1x 10/100/1000 Mbit
	USB	1x USB 2.0 host, 1x USB device
	Serial	1x RS232
Backup	Settings	Saved permanently to flash memory
Standards	Product standard	
	Information technology equipment – Safety	EN 60950-1
	Conformity, approvals, certification, compatibility	
		CM1T9292xx
		CM1T9292xx_Cx

Standards (continued)

	http://database.ul.com/
	http://directories.csa-international.org/
	47 CFR Part 15 Class B

Degree of protection	Protection class	III as per EN 60950-1 (if installed correctly)
	Housing	Front: IP54 Rear: IP20 As per EN 60529 (if installed correctly)
	Degree of pollution	2 as per EN 60950-1

Environmental compatibility	The product environmental declaration CM1E9292en contains data on environmentally compatible product design and assessments (RoHS compliance, materials composition, packaging, environmental benefit, disposal)	ISO 14001 (environment) ISO 9001 (quality)
-----------------------------	--	---

Dimensions	See "Dimensions"	
Weight	Unit complete with accessories	3.2 kg
Housing material	Front	Aluminum, colorless anodized and glass
	Rear	Stainless steel

Ambient conditions	Operation	Transport	Storage
	EN 60721-3-3	EN 60721-3-2	EN 60721-3-1
Climatic conditions	Class 3K5	Class 2K3	Class 1K3
Temperature	0...+50 °C	-25...+70 °C	-20...+65 °C
Humidity	< 95% r.h. (non-condensing)	< 95% r.h.	< 95% r.h.
Mechanical conditions	Class 3M2	Class 2M2	Class 1M2
Elevation above sea level	Min. 700 hPa, corresponds to a maximum of 3000 meters above sea level.		

Connections

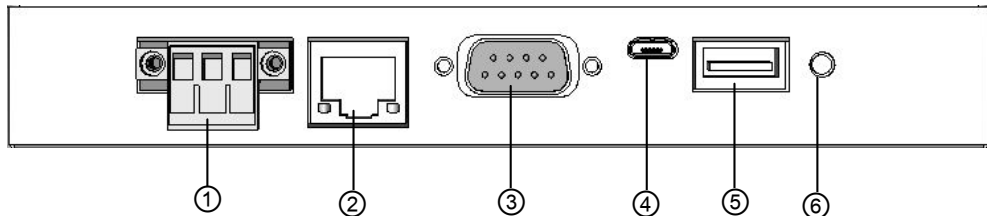

- ① 24 V AC/DC
- ② LAN RJ45
- ③ COM
- ④ Micro USB device
- ⑤ USB host
- ⑥ Reset

Dimensions

All dimensions in mm

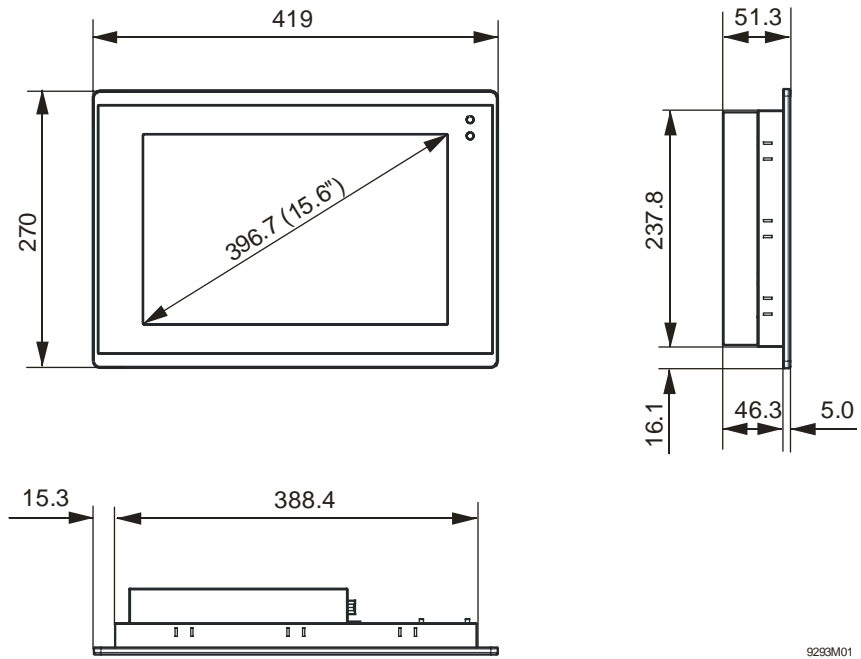

Cutout for PXM50

A cutout dimensioned as follows is required to mount the touch panel in the control panel door.

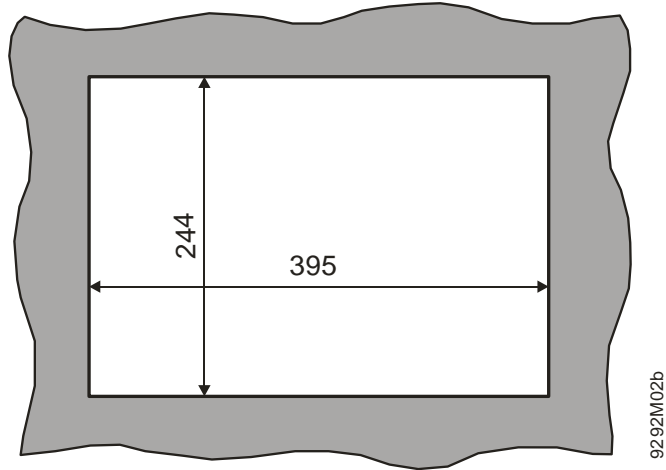

Wall thickness: 1 mm to 4 mm

